

East Wall

NOTE:  
- Added positions are drawn out of style for clarity purposes  
- Please use 2" schedule 40 pipe

NOTE:  
- Channels 48 & 170 should be hung on the undercat

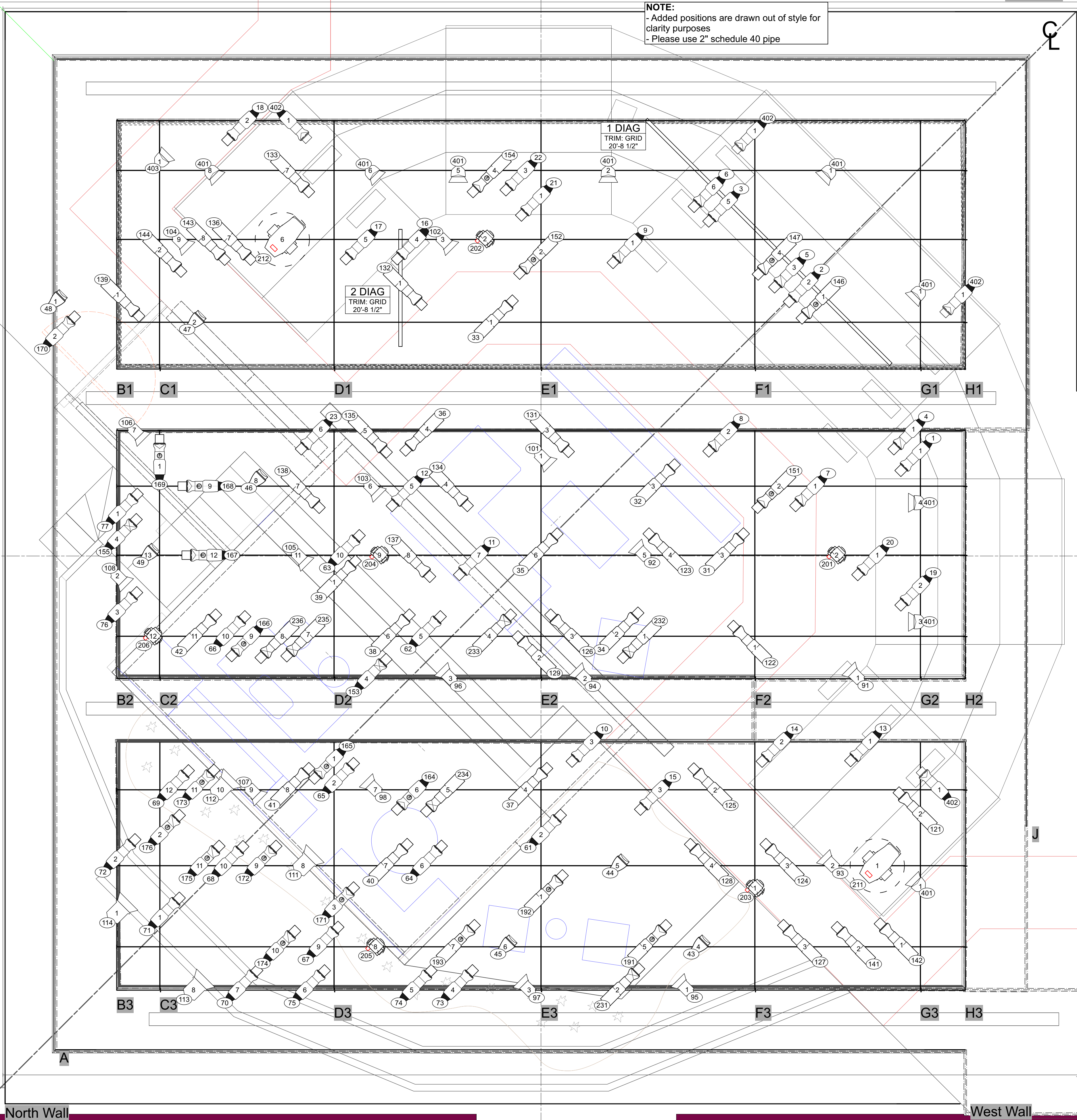

1 PIPE

2 PIPE

3 PIPE

4 PIPE

5 PIPE

6 PIPE

South Wall

7 PIPE

8 PIPE

9 PIPE

10 PIPE

11 PIPE

12 PIPE

13 PIPE

14 PIPE

15 PIPE

16 PIPE

17 PIPE

North Wall

West Wall

- Accessories
- 6.25in Top Hat
  - 7.5in 4 Leaf Barn Door
  - 7.5in Concentric Ring
  - 10in Barn Door

SYMBOL KEY

- Altman 6in Fres
- Altman 8in Fresnel
- ETC Source4 PAR WFL
- ETC ColorSource PAR DB No Lens
- ETC ColorSource Spot 19deg
- ETC ColorSource Spot 26deg
- ETC ColorSource Spot 36deg
- ETC ColorSource Spot 50deg
- ETC Source4 19deg 750W
- ETC Source4 26deg 750W
- ETC Source4 36deg 750W
- ETC Source4 50deg 750W
- Robe Robin LEDBeam 150
- High End SolaHyBeam 2000

TYPICAL

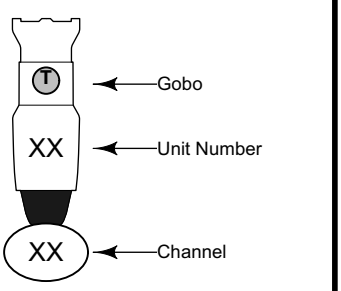

NOTES

- All Source 4 and ColorSource Spot fixtures should be hung with a top hat
- All ColorSource PAR fixtures should be hung with concentric rings
- All fresnel fixtures should be hung with the appropriate barn door



UMD School of Theatre, Dance, and Performance Studies

PRESENT

STICK FLY

- Director.....KenYatta Rogers
- Lighting Designer.....Christian D. Henriquez
- Scenic Designer.....Abigail Buetti
- Costume Designer.....Ashlynn Ludwig
- Sound Designer.....Niel McFadden
- Media Designer.....Zavier L. Taylor
- Technical Director.....Mark Rapach
- Production Manager.....Jenn Schwartz
- Stage Manager.....Safiya Muthaliff

KOGOD THEATRE

LIGHTING DESIGNER

**Christian D. Henriquez** **CH**  
Phone: (714) 318-1985  
Email: cdhen@umd.edu

Please report any errors or omissions to the designer. If in doubt, ASK! This drawing represents design intent and construction suggestions only. The designer is unqualified to determine the structural or electrical appropriateness of this design and will not assume responsibility for improper engineering, construction, handling, or use.

LIGHTING TEAM

- Master Electrician: Carrie Barton
- Asst. Lighting Designer: Luis Garcia
- Phone: N/A
- Phone: (321) 442-7459
- Email: cbarton@umd.edu
- Email: lueg@umd.edu

E		
D		
C		
B		
A	Scenic Updates	03/24/2022
REV	DESCRIPTION	DATE

OVERHEAD

SCALE: 3/8" = 1'-0"  
EXCEPT WHERE NOTED  
DATE: 3/24/22  
REVISION: A  
DRAWN BY: CDH

DRAWING  
**1**  
OF 4

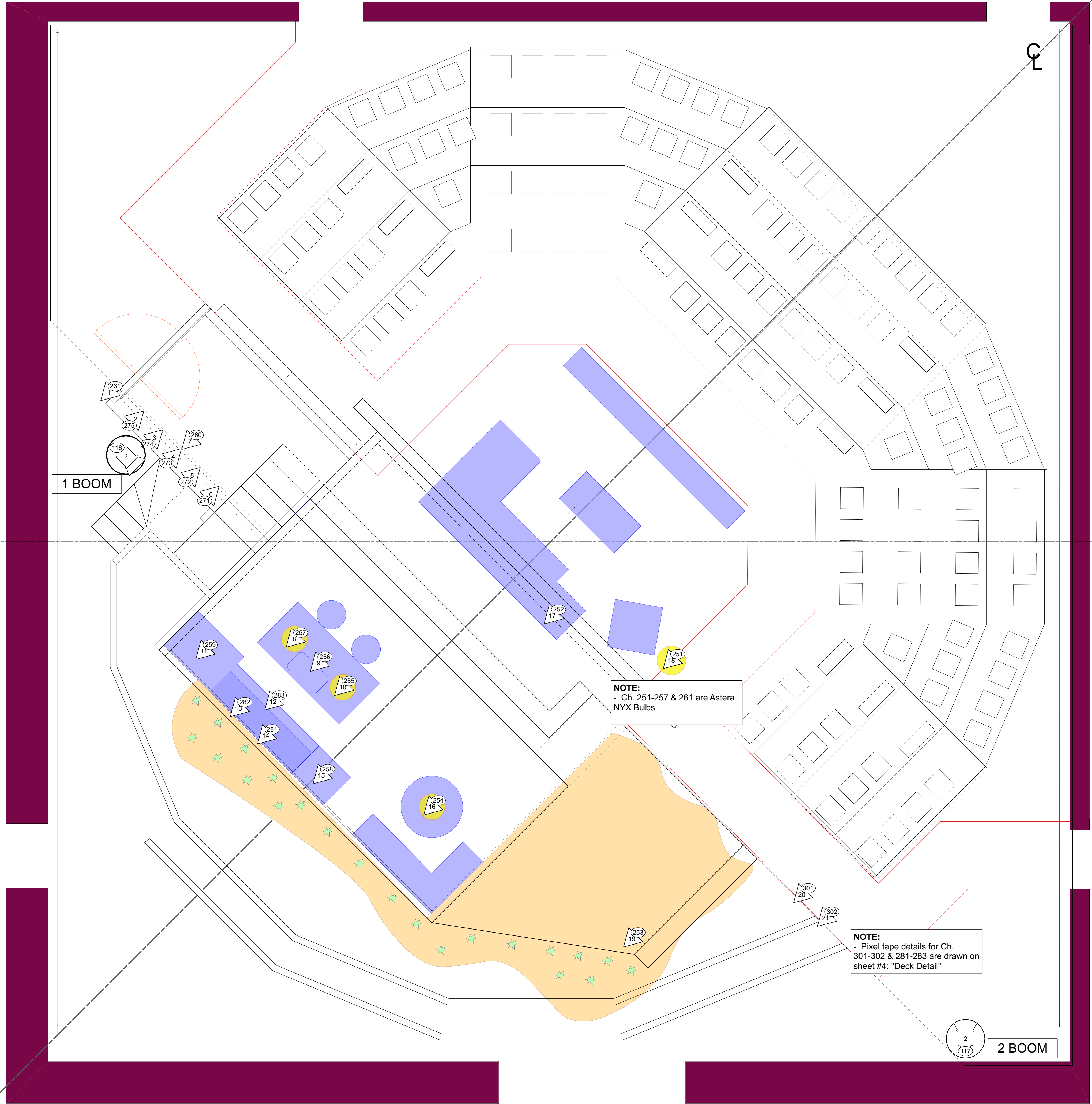

**NOTE:**  
- Details for Ch. 271-275 & 260 are on sheet #4: "Deck Detail"

**NOTE:**  
- Ch. 251-257 & 261 are Astera NYX Bulbs

**NOTE:**  
- Pixel tape details for Ch. 301-302 & 281-283 are drawn on sheet #4: "Deck Detail"

**NOTE:**  
- Fixtures on both booms should be hung on a side arm on the DS side of the boom

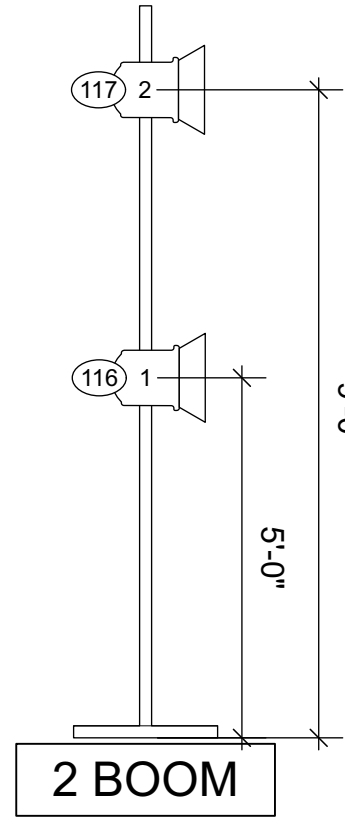
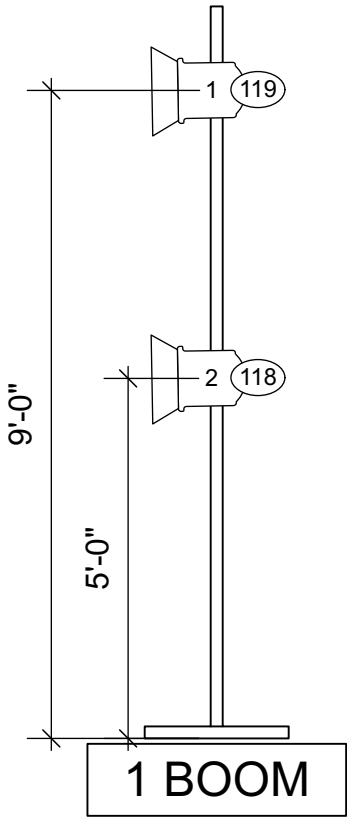

**SYMBOL KEY**

- ◻ Altman Bin Fresnel
- △ USITT Practical
- ◡ 10in Barn Door

---

**TYPICAL**

**NOTES**

UMD School of Theatre, Dance, and Performance Studies  
PRESENT:

**STICK FLY**

Director.....KenYatta Rogers  
Lighting Designer.....Christian D. Henriquez  
Scenic Designer.....Abigail Buetti  
Costume Designer.....Ashlynnne Ludwig  
Sound Designer.....Niel McFadden  
Media Designer.....Zavier L. Taylor  
Technical Director.....Mark Rapach  
Production Manager.....Jenn Schwartz  
Stage Manager.....Safiya Muthaliff

**KOGOD THEATRE**

**LIGHTING DESIGNER**  
**Christian D. Henriquez** CH  
Phone: (714) 318-1985  
Email: cdhen@umd.edu

Please report any errors or omissions to the designer. If in doubt, ASK! This drawing represents design intent and construction suggestions only. The designer is unqualified to determine the structural or electrical appropriateness of this design and will not assume responsibility for improper engineering, construction, handling, or use.

**LIGHTING TEAM**

Master Electrician: Carrie Barton Phone: N/A Email: cbarton@umd.edu	Asst. Lighting Designer: Luis Garcia Phone: (321) 442-7459 Email: lueg@umd.edu
------------------------------------------------------------------------------	-----------------------------------------------------------------------------------------

E		
D		
C		
B		
A	Scenic Updates	03/24/2022
REV	DESCRIPTION	DATE

**DECK**

SCALE: 3/8" = 1'-0"  
EXCEPT WHERE NOTED  
DATE: 3/24/22  
REVISION: A  
DRAWN BY: CDH

DRAWING  
**2**  
OF 4

**DETAIL: FISHSCALE SHINGLE**  
CL SECTION | SCALE: 1" = 1'-0"

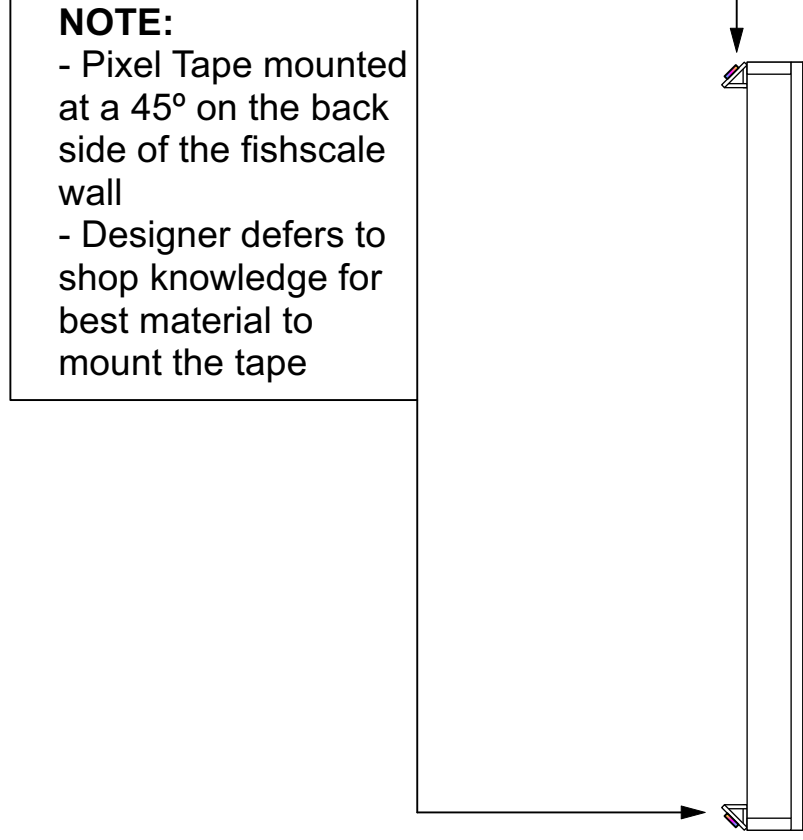

**DETAIL: FISHSCALE SHINGLE**  
REAR VIEW | SCALE: 1/2" = 1'-0"

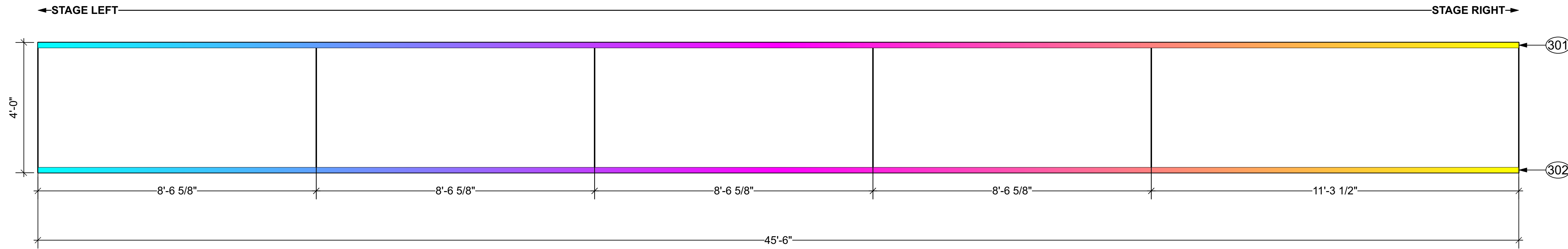

**NOTE:**  
- Pixel Tape mounted on US side of fish scale shingles to illuminate lighting surround  
- Channel control to start at SR

**SYMBOL KEY**

- Altman 8in Fresnel
- ETC ColorSource PAR DB No Lens
- ETC ColorSource Spot 19deg
- ETC ColorSource Spot 26deg
- ETC ColorSource Spot 36deg
- ETC ColorSource Spot 50deg
- ETC Source4 26deg 750W
- ETC Source4 36deg 750W
- Robe Robin LEDBeam 150
- USITT Practical
- 6.25in Top Hat

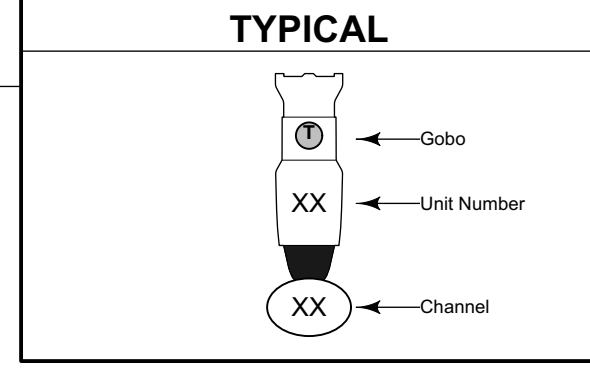

**NOTES**



UMD School of Theatre, Dance, and Performance Studies  
PRESENT:  
**STICK FLY**  
Director.....KenYatta Rogers  
Lighting Designer.....Christian D. Henriquez  
Scenic Designer.....Abigail Buetti  
Costume Designer.....Ashlynn Ludwig  
Sound Designer.....Niel McFadden  
Media Designer.....Zavier L. Taylor  
Technical Director.....Mark Rapach  
Production Manager.....Jenn Schwartz  
Stage Manager.....Safiya Muthaliff

**DETAIL: FOYER WALL**  
ELEVATION | SCALE: 1/2" = 1'-0"

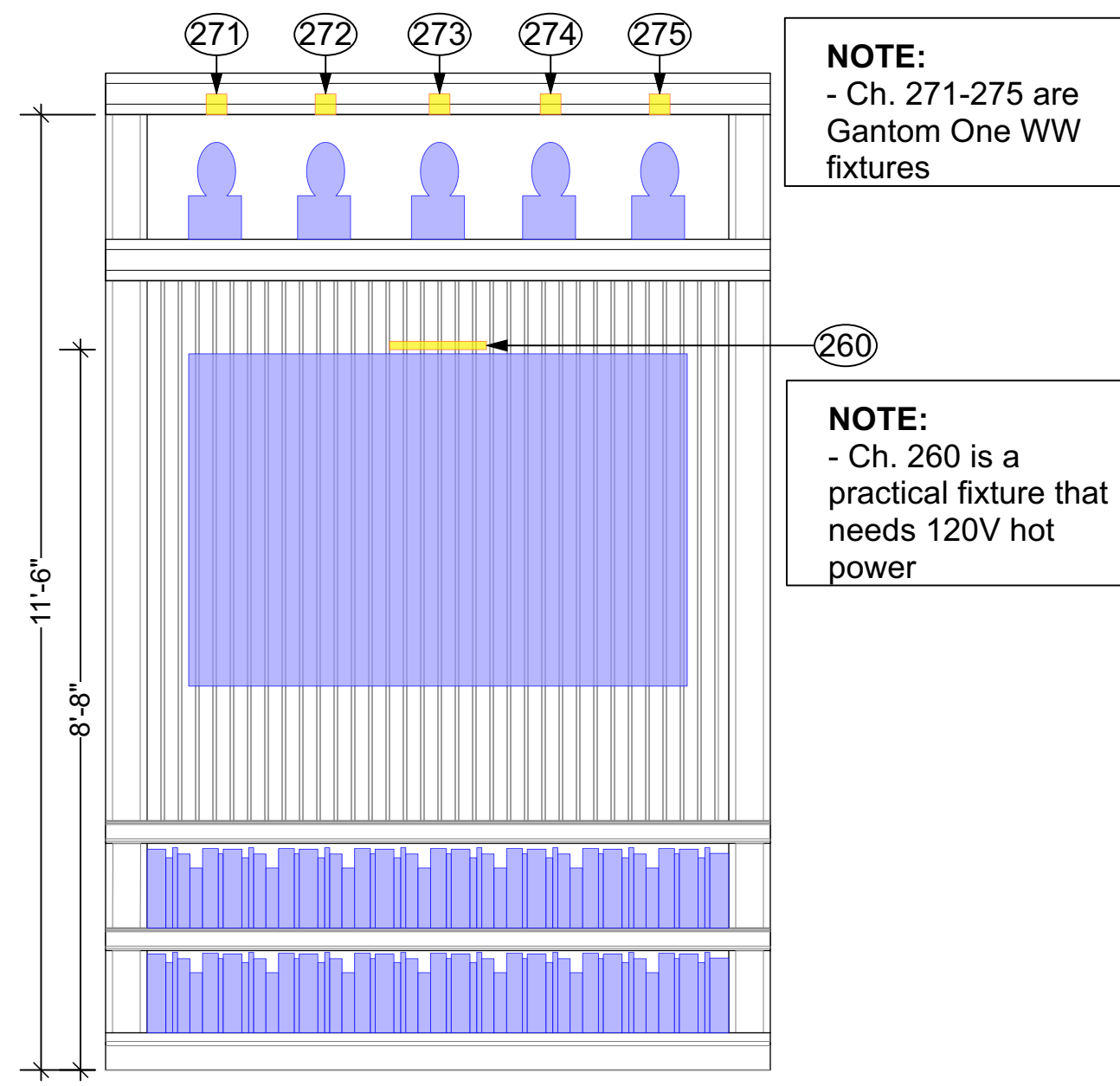

**DETAIL: FRONT DOOR**  
ELEVATION | SCALE: 1/2" = 1'-0"

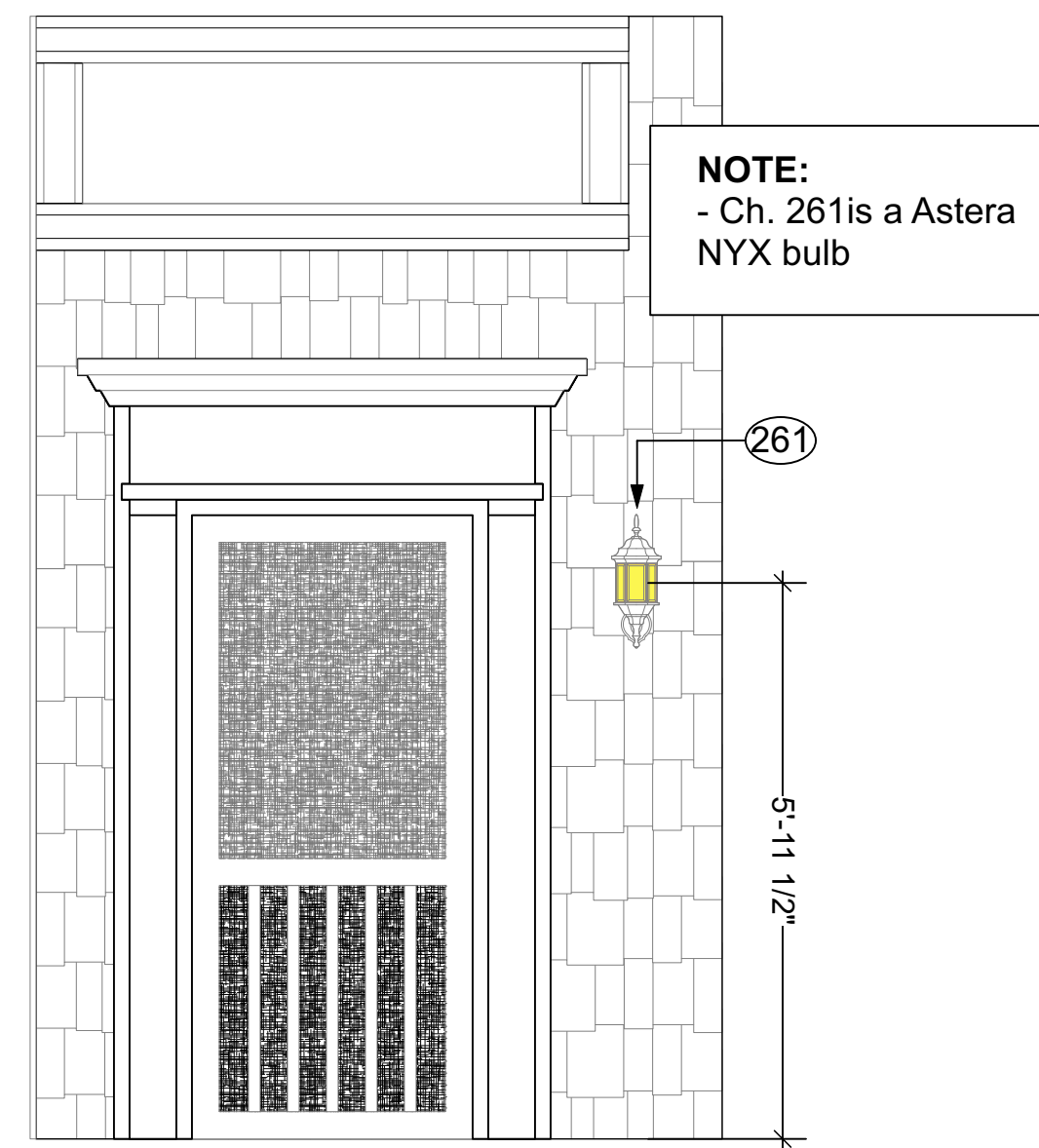

**DETAIL: CABINETS**  
ELEVATION | SCALE: 1" = 1'-0"

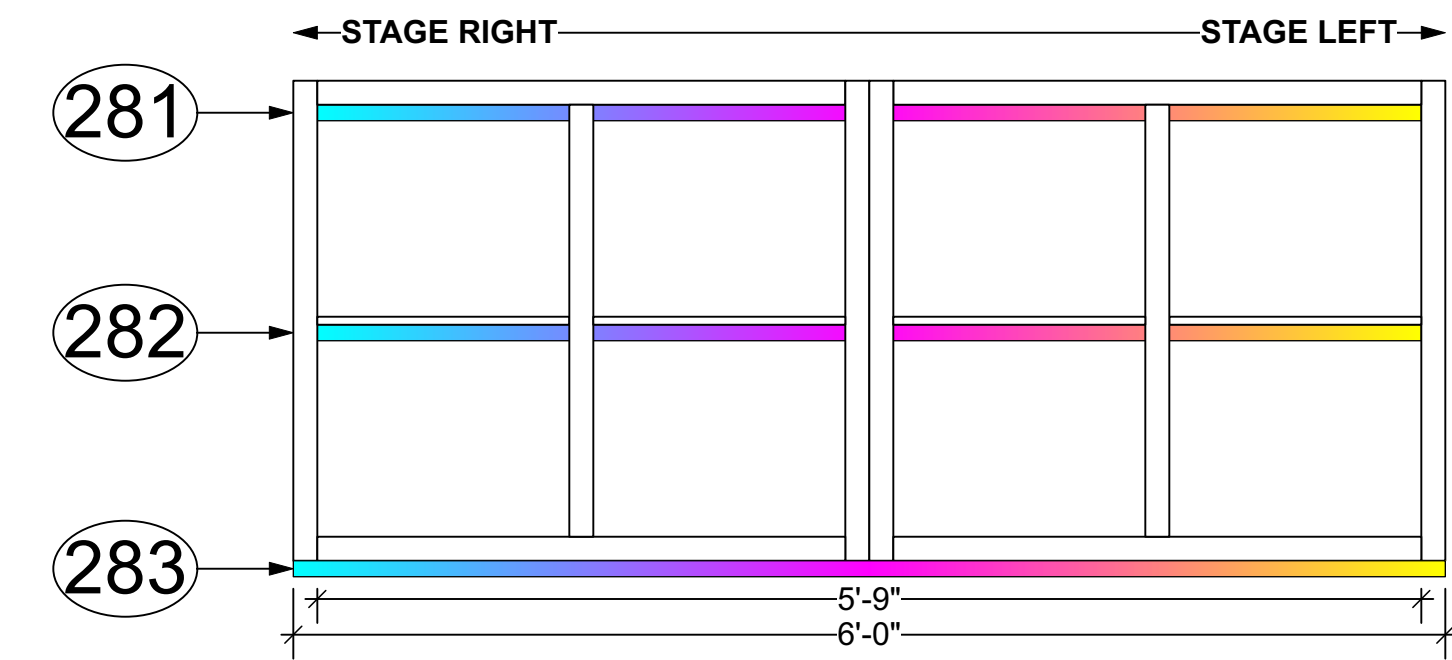

**NOTE:**  
- Pixel Tape mounted on US edge of the cabinets  
- Pixel Tape mounted facing down  
- Channel control to start at SR  
- Pixel Tape covered with OS-40 for diffusion

**DETAIL: PORCH**  
ELEVATION | SCALE: 1/2" = 1'-0"

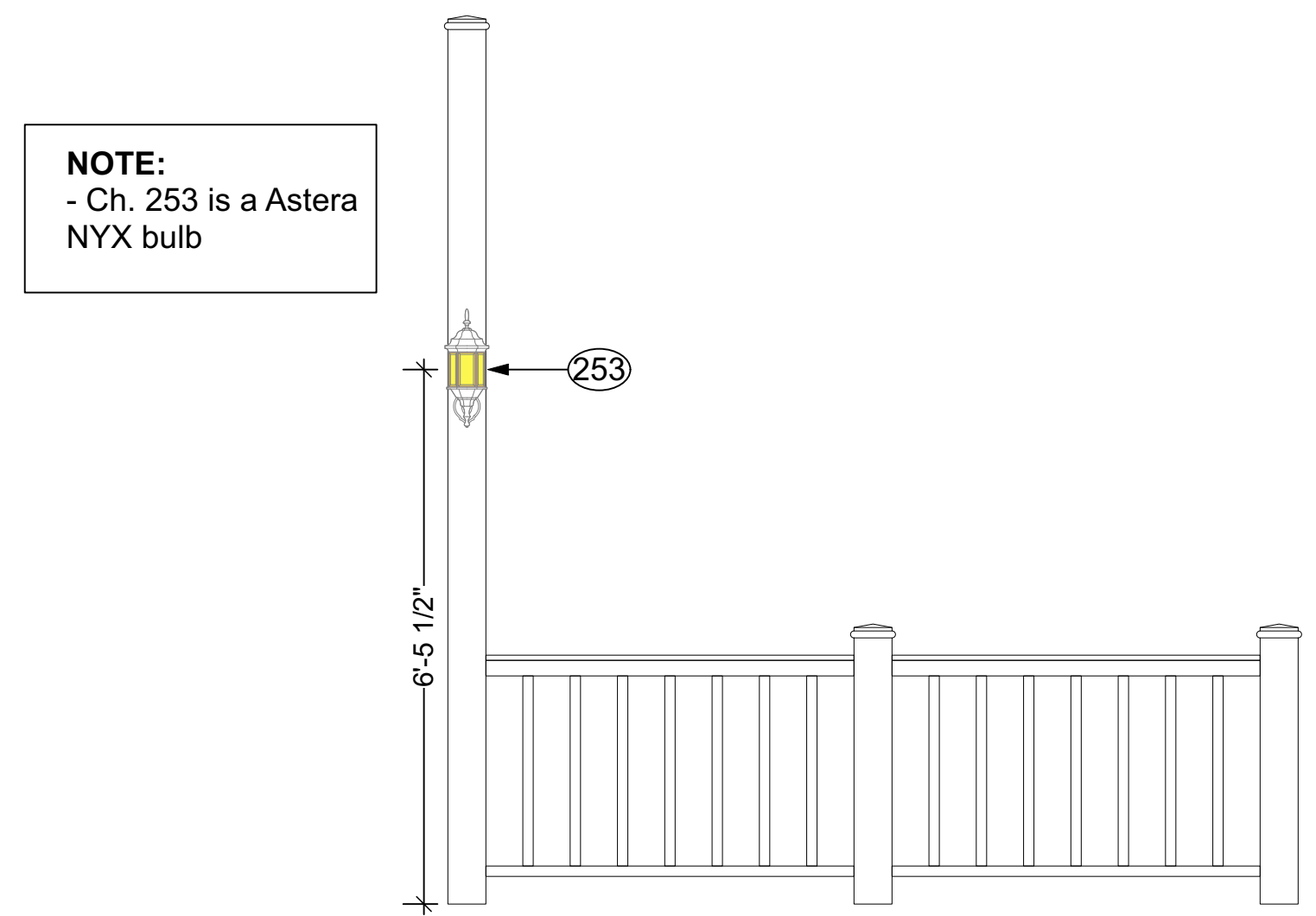

**DETAIL: CABINETS**  
BOTTOM VIEW | SCALE: 1" = 1'-0"

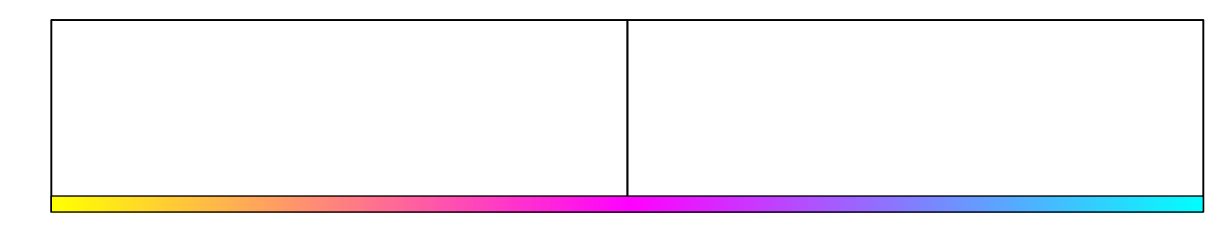

**NOTE:**  
- Shown for reference  
- Pixel Tape should be mounted to the US edge of the cabinets

**KOGOD THEATRE**

**LIGHTING DESIGNER**  
Christian D. Henriquez    CH  
Phone: (714) 318-1985  
Email: cdhen@umd.edu

Please report any errors or omissions to the designer. If in doubt, ASK! This drawing represents design intent and construction suggestions only. The designer is not qualified to determine the structural or electrical appropriateness of this design and will not assume responsibility for improper engineering, construction, handling, or use.

**LIGHTING TEAM**  
Master Electrician: Carrie Barton  
Asst. Lighting Designer: Luis Garcia  
Phone: N/A    Phone: (321) 442-7459  
Email: cbarton@umd.edu    Email: lueg@umd.edu

E		
D		
C		
B		
A	Scenic Updates	03/24/2022
REV	DESCRIPTION	DATE





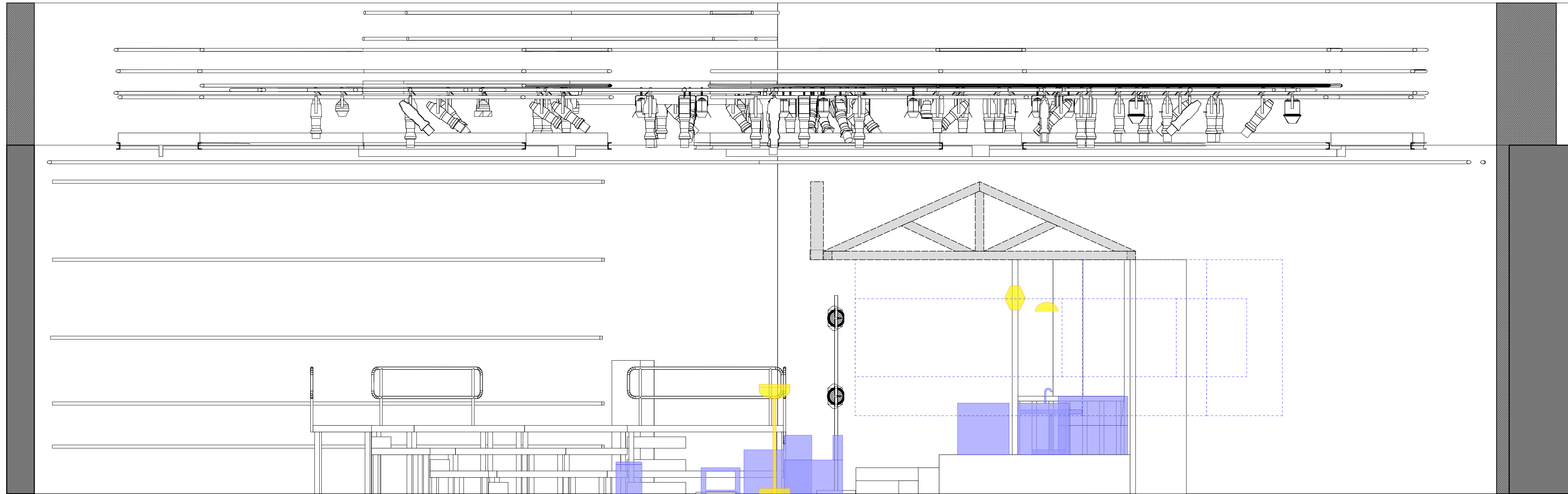

**DECK DETAIL**

SCALE: AS NOTED  
EXCEPT WHERE NOTED  
DATE: 3/24/22  
REVISION: A  
DRAWN BY: CDH

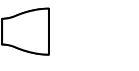
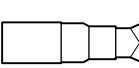
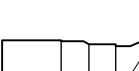
DRAWING  
**3**  
OF 4

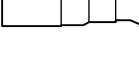
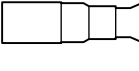
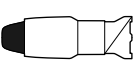
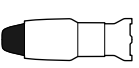

**SYMBOL KEY**

-  Altman 8in Fresnel
-  ETC ColorSource PAR DB No Lens
-  ETC ColorSource Spot 19deg
-  ETC ColorSource Spot 26deg
-  ETC ColorSource Spot 36deg
-  ETC ColorSource Spot 50deg
-  ETC Source4 26deg 750W
-  ETC Source4 36deg 750W
-  Robe Robin LEDBeam 150
-  USITT Practical
-  6.25in Top Hat
-  High End SolaHyBeam 2000

**TYPICAL**

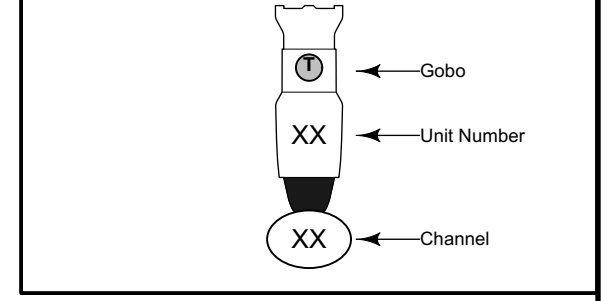

**NOTES**



UMD School of Theatre, Dance, and Performance Studies  
PRESENT:  
**STICK FLY**

Director.....KenYatta Rogers  
Lighting Designer.....Christian D. Henriquez  
Scenic Designer.....Abigail Buetti  
Costume Designer.....Ashlynn Ludwig  
Sound Designer.....Niel McFadden  
Media Designer.....Zavier L. Taylor  
Technical Director.....Mark Rapach  
Production Manager.....Jenn Schwartz  
Stage Manager.....Safiya Muthaliff

**KOGOD THEATRE**

**LIGHTING DESIGNER**

**Christian D. Henriquez** **CH**  
Phone: (714) 318-1985  
Email: cdhen@umd.edu

Please report any errors or omissions to the designer. If in doubt, ASK! This drawing represents design intent and construction suggestions only. The designer is unqualified to determine the structural or electrical appropriateness of this design and will not assume responsibility for improper engineering, construction, handling, or use.

**LIGHTING TEAM**

<b>Master Electrician:</b> Carrie Barton Phone: N/A Email: cbarton@umd.edu	<b>Asst. Lighting Designer:</b> Luis Garcia Phone: (321) 442-7459 Email: lueg@umd.edu
-------------------------------------------------------------------------------------	------------------------------------------------------------------------------------------------

E		
D		
C		
B		
A	Scenic Updates	03/24/2022
REV	DESCRIPTION	DATE

**SR SECTION**

SCALE: 3/8" = 1'-0" <small>EXCEPT WHERE NOTED</small>	DRAWING
DATE: 3/24/22	<b>4</b>
REVISION: A	
DRAWN BY: CDH	OF 4